

Article number: 12709000050700

Description: KLEE-coil 709 000 050.700
M5 Light-alloy metal

Measures

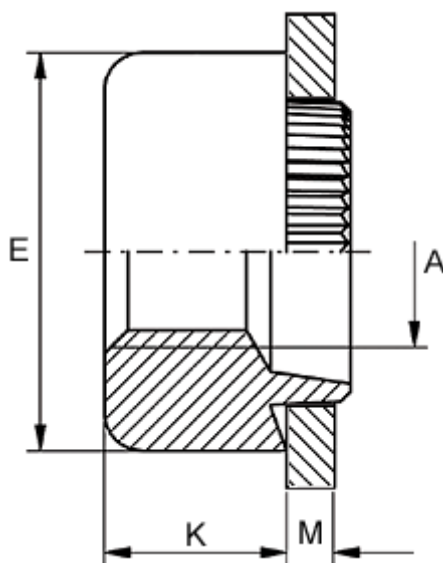

Female thread A	= M5
Height K	= 3.0
Outer diameter E	= 11.0
Plate thickness	= 2.3 to 2.5
Recommended bore diameter for extreme load	= 8.0
Recommended bore diameter for normal use	= 8.0